

DENTIS DENTIS DENTIS HELLO! Ver.E5

IMPLANT



Tel. +82-53-583-2804 | Fax. +82-53-583-2806
99, Seongseoseo-Ro, Dalseo-Gu, Daegu, Korea



Tel. +1-323-677-4363 | Fax. +1-323-677-4366
11095 Knott Ave. ABC, Cypress CA 90630



Tel. +021-5111-3828 | Fax. +021-5111-3828
上海市长宁区中山西路933号2205室



Tel. +34 91 072 62 27 | <https://dentiseurope.com/>
Travesía C. Doctor Fleming, 16

©2023 DENTIS CO.,LTD.
All Right Reserved.
Specifications are subject to change without notice.
Trademarks are the property of DENTIS CO., LTD. Or their respective owners.

D-C-SALESD-202307-ENG(V5)



Head office (Korea)

덴티스 임플란트

Implant Factory (Korea)



SQ
IMPLANT
SYSTEM

A clean implant for all

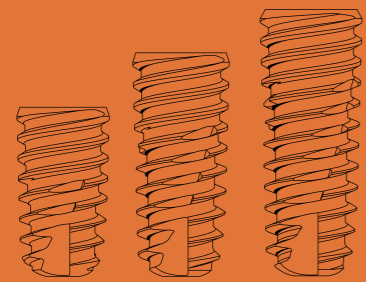

ZENITH
3D PRINTER
SOLUTION

An innovative 3D printer in
hopes of the better world



LUVIS
SURGICAL
LED LIGHT

The World-Class LED Surgical Light
takes the lead in advancement of
the medical treatment



OVIS
BIO
TECHNOLOGY

A stable bio-material developed by
advanced technology



Protocol for implants with high quality repeated cleaning, precise washing, and cutting-edge automation.

DENTIS Implant Cleaning Process System



VIDEO

Iterative
Cleaning

Ultra-
precise
Cleaning

Automated
System

DENTIS
Implant

1



Inspection to select raw materials

Select verified raw materials with great quality such as titanium, and stock them only after inspecting them.

2

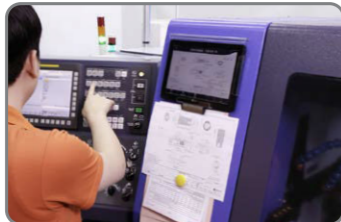

CNC production

Produce implants with CNC equipment according to the automation process.

3

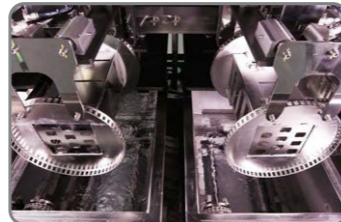

Primary washing

Primary washing (fat removal) with four tubs to eliminate cutting out oil.

4

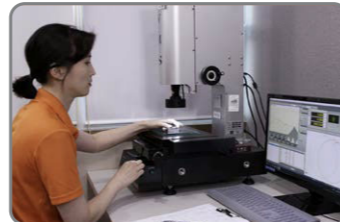

Inspection

The cleansed implants go through a verification process through sample tests using microscopes and ultraprecise assessment equipment.

5



Follow-up

Implants that have gone through inspection are subject to follow-up processes to remove debris, such as Burr.

6



**Secondary washing
(half-finished product)**

Cleansing through six tubs in a half clean room to match ultraprecise washing standards.

✓ CHECK POINT 1



Purified water used for washing

The water used for washing in all processes is "DI Water," which perfectly blocks any reproduction of bacteria or microorganisms, and goes through independent manufacturing and strict management.

7



Inspection

Assess the cleansing state of the implant after the secondary washing.

8



Surface process on blasting

Blasting to make rough surfaces of the implant, such as SLA, RBM, and HA with robot automation equipment.

SLA : use of amumina powder
RBM/HA : use of mcd powder

✓ CHECK POINT 2



Robot automation system

Monitor the process in real time and blast the various implant surfaces in detail.

9



Inspection

10



Surface etching (SLA)

SLA products are additionally cleaned in three tubs to eliminate acid after etching the surfaces in the clean room.

11



Tertiary washing

Implants with completed surfaces are cleaned in six tubs in the half clean room.

12

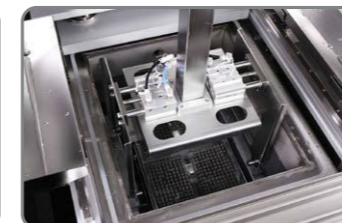

Quaternary washing

There is another 7-tub cleansing in the clean room, going through a 13-step cleanse.

13

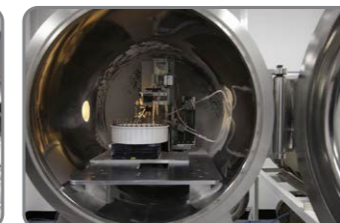

Surface coating (HA)

HA products go through additional coating with HA powders in a separate room.

14



Additional washing (HA)

HA surface implants that have gone through coating are cleaned again using five tubs.

15

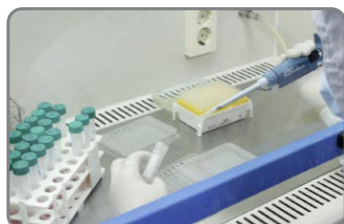

Cytotoxicity Inspection

Completed implants that have gone through the final cleanse are subject to cytotoxicity inspections.

16

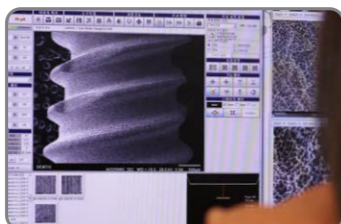

SEM inspection

Quality assessment through SEM inspections.

17



Packaging

Implants are placed in ampoules and packaged in carton boxes with automatic packaging.

18



Gamma Ray Sterilization

All DENTIS implants go through 100% gamma ray sterilization.

19

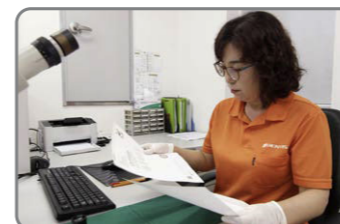

Sterilization test

20



Completion and Release

Completed products are stocked in the warehouse and released to the world.

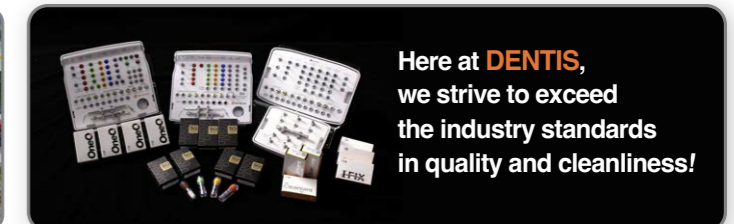

Here at **DENTIS**, we strive to exceed the industry standards in quality and cleanliness!

Stress free implant placement
with qualified result. It's SQ.

The Superior of SQ WIDE

- High initial stability**
tapered design & dual thread
- Smoother insertion**
3~4 Blade & Helical wide cutting edge
- Improved joint-stability**

(compatible with the whole OneQ & SQ)
- Simple and easy depth control**
Shorter length with 0.5mm
- S.L.A Surface**
200% increased surface roughness compared with RBM leads to more effective & faster Osseointegration
- Strict cleaning**
30 stages of the automatic cleaning system
- Specifications**

| | | | | | | | |
|-----------|----------------------|----------|----------|-------|-----------------|-------|-------|
| Diameter | 3.5 | 4.0 | 4.5 | 5.0 | 6.0 | 7.0 | 8.0 |
| Fixture | | | | | | | |
| Length | 7 / 8 / 10 / 12 / 14 | | | | 7 / 8 / 10 / 12 | | |
| Hex | 1.7 HEX | | | | | | |
| Color | | | | | | | |
| Guideline | Anterior | Anterior | Premolar | Molar | Molar | Molar | Molar |

S-Line Healing Abutment

| | |
|----------|---------------------------|
| Diameter | 4.5 / 5.5 / 6.5 / 7.5 |
| Cuff | 2 / 3 / 4 / 5 / 6 / 7 / 9 |

Non Sanding Only Etching surface
Improves the nature of the relationship of the soft tissue with the implant surface

Sharp Thread

4 Blade Chip Pocket
Maximizes self-tapping

7° Tapered Design
Increases stability in cortical bone area

2 Helical Cutting-Edge Design

3° Tapered Design
Softer Implantation

20° Tapered Design
Be smoothly inserted without additional drilling

Specifications

| | | | |
|-----------|-----------------|-------|-------|
| Diameter | 6.0 | 7.0 | 8.0 |
| Fixture | | | |
| Length | 7 / 8 / 10 / 12 | | |
| Hex | 1.7 HEX | | |
| Color | | | |
| Guideline | Molar | Molar | Molar |

TQ Tissue level Qualified is Reliable, Stronger and Safe.

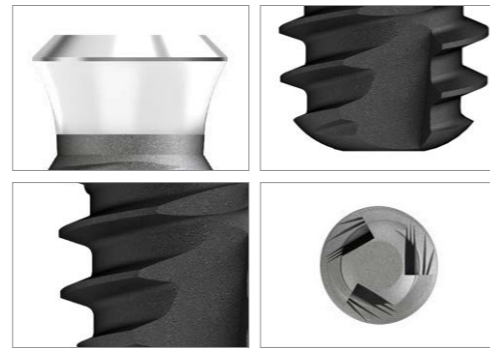
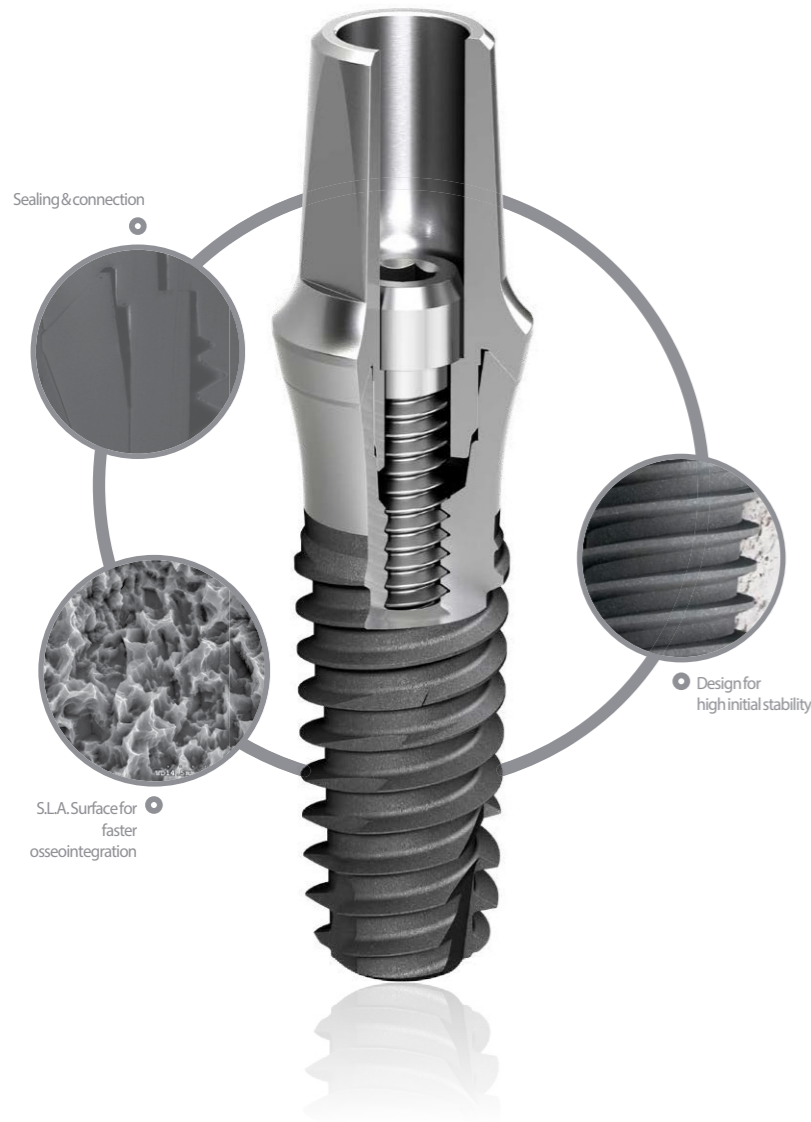

High Initial Stability

- Tapered design
- Dual & Double Thread

Smoother Insertion

- 3 Blade & Helical wide cutting edge



THE SHORT THAT ATTACHED FIRMLY TO THE BONE

Safe and Strong Placement

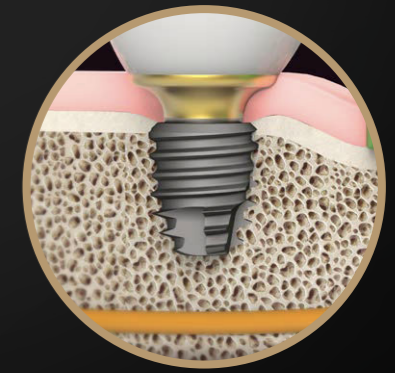

Machined Surface

Strengthening the Bonding force with soft tissue

Single Thread

Stable depth control

4 Blade Chip Pocket

Maximize Self-Tapping Capabilities

Abundant variation covers all indication

| Class | Regular | Wide | |
|-------------------|-------------------------------|--------------------------|-------------------------|
| Platform Diameter | ø 4.8 | ø 6.5 | |
| Cuff | 1.8 / 2.8mm | | |
| Body Diameter | ø 3.5 / 4.0 / 4.5 / 5.0 / 5.5 | ø 5.0 / 5.5 | ø 6.0 / 7.0 |
| Length | 7.5 / 8 / 10 / 12 / 14mm | 7.5 / 8 / 10 / 12 / 14mm | 6.5 / 7 / 8 / 10 / 12mm |
| Connection | Octa | | |
| Thread | Double Thread | | Single Thread |

SQ-Short Fixture Line-Up

| Fixture Diameter | Length | Machined Collar | Code No. |
|------------------|--------|-----------------|-------------|
| 5.0 | 6.0mm | 2.0mm | DSSFR5004S |
| | | 1.0mm | DSSFR5005S |
| | | 0mm | DSSFR5006S |
| | 7.0mm | 2.0mm | DSSFR5005LS |

DENTIS OneQ Implant

One system for all implant indication



Abundant variation covers all indication

OneQ rich line-up is enough to cover all cases

| Class | Narrow | Regular | Wide |
|------------|--------------------|--------------------|--------------------|
| Diameter | Ø3.0/3.3 | Ø3.9/4.2/4.7/5.2 | Ø6.0/7.0/8.0 |
| Length | 8/10/12/14 | 7/8/10/12/14 | 6/7/8/10/12 |
| Connection | Double Hex | Hex | |
| Body | Straight | Tapered + Straight | |
| Thread | Double lead Thread | | Single lead Thread |

Design for high initial stability

- Double tapered design implant body (Regular & Wide) Straight body & tapered head design may allow easier depth control and stable & proper primary fixation
- Cutting groove boosts self tapping ability and enable to smaller osteotomy which may helps to get earlier stability.

Sealing & connection

11degree tapered Internal connection with Hexagonal locking prevent micro-gap andmicro move

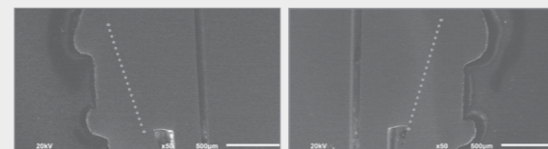

S.L.A Surface for faster osseointegration

Effective & Excellent Osseo-integration

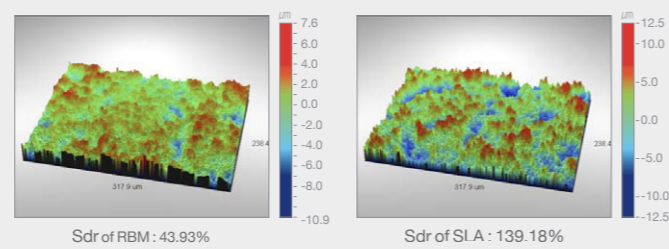
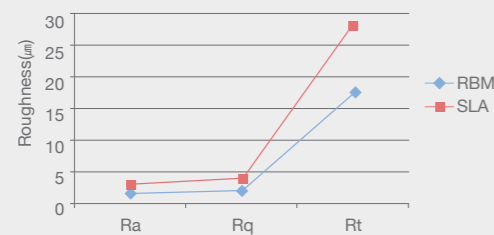

For Wide Extraction Socket

Designed for more convenience surgery in wide extraction socket.

Reversed Taper Head

0.7mm Reversed Tapered Head helps bone reconstruction and also supports soft tissue



Be Original, Cleanlant Implant



Optimum RBM Surface

- Optimized 1.3–1.8µm of roughness
- 192% more increased roughness than machine surface.
- No chemical reaction and residues on surface

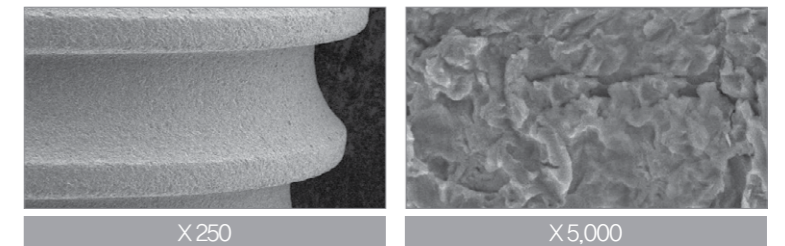

Long-Term Stability

1) 10 years of clinical follow-up

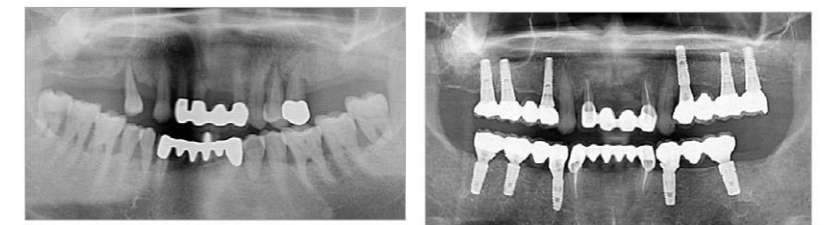

Fig.1 Pre-op panorama (May 19, 2008). 42-year-old female patient was showing for implants placement on missing area.

Fig.9 Post-op 10yrs panorama (July. 18, 2018). Final prosthesis were delivered.

2) Multi-clinical retrospective study

* 1,429 Cleanlant implants were placed

Result

Average time since implant placement were 26 months, Average time since delivery of prosthesis was 21 months, 27 implants out of 1429 implants had to be removed before delivery of definitive restorations for various clinical failure criteria, resulting in a failure rate of 1.9%. Cumulative survival rate was 98.1%.

Average age of the patient population was 52 years old at the time of implant placement surgery, while youngest patient was 16 years old and oldest patient was 87 years old, 52.7% of the patient population was female, while 47.3% was male. While maxillary molar region had the highest risk of failures anatomically,

diabetes and smoking were the highest medical condition risk factors, Prosthetic complication factors such as screw loosening, cemented crowns coming-off, and porcelain fractures affected 36 implants, resulting in 4.8% prosthetic complication rate for the 26 months of this study.

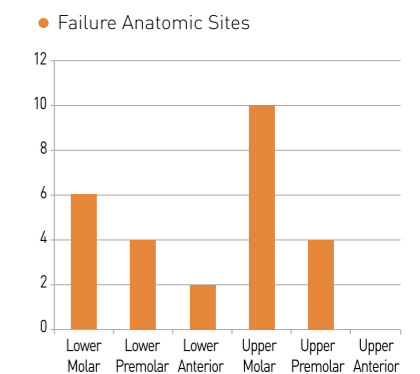
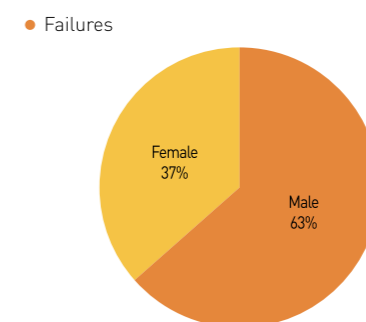
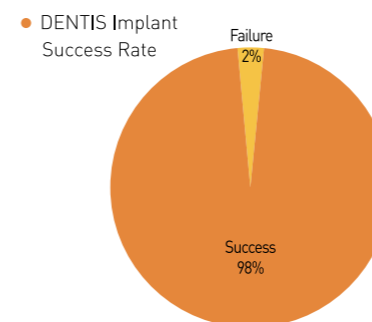

DENTIS OneQ – Internal Implant

A classic one-stage implant to simplify the treatment complexity

Platform Diameter Ø4.8 (Regular)

Platform Diameter Ø6.5 (Wide)

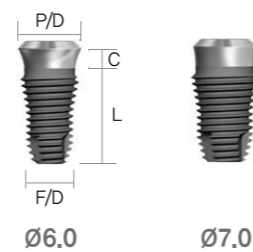
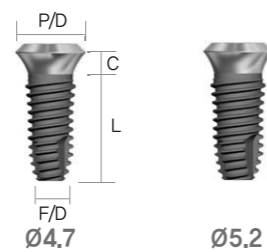
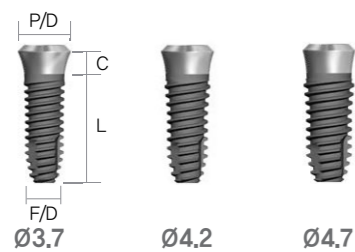

| P/D | F/D | Length | Cuff |
|------|----------------------|--------|------------|
| Ø4.8 | Ø3.7 Ø4.2 Ø4.7 | 7.0mm | 2mm 3mm |
| | | 8.0mm | |
| | | 10.0mm | |
| | | 12.0mm | |

| P/D | F/D | Length | Cuff |
|------|--------------|--------|------------|
| Ø6.5 | Ø4.7 Ø5.2 | 7.0mm | 2mm 3mm |
| | | 8.0mm | |
| | | 10.0mm | |
| | | 12.0mm | |

| P/D | F/D | Length | Cuff |
|------|--------------|--------|------|
| Ø6.5 | Ø6.0 Ø7.0 | 6.0mm | 2mm |
| | | 7.0mm | |
| | | 8.0mm | |
| | | 10.0mm | |

• Design for high initial stability

- Double tapered design implant body (Regular & Wide)
- Straight body & tapered head design may allow easier depth control and stable & proper primary fixation
- Cutting groove boosts self tapping ability and enable to smaller osteotomy which may helps to get earlier stability.

• S.L.A Surface for faster osseointegration

- 200% enhanced surface area compare to RBM surface.

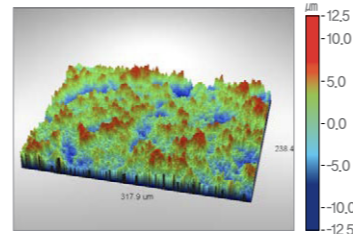
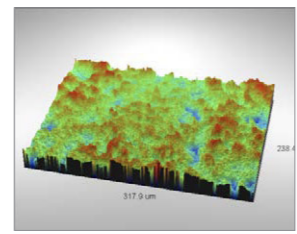
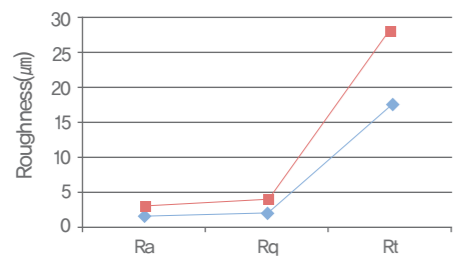

• Sealing & connection

- 11 degree tapered Internal connection with Hexagonal Locking prevents micro-gap and movement.



Naturally smiling, laughing and eating

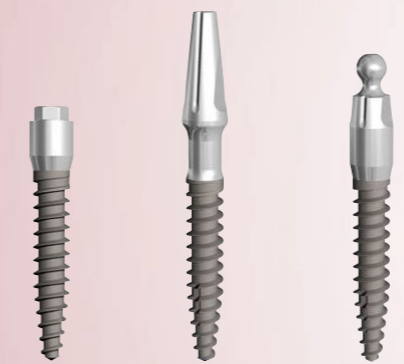
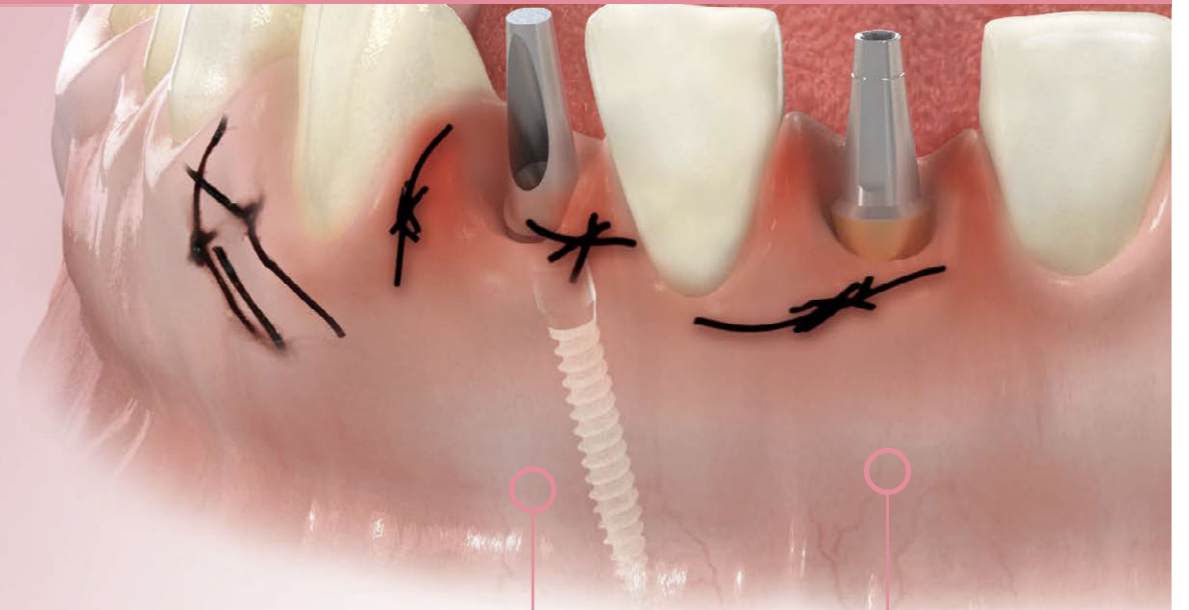

Angle Type Post Type O-Ring Type

Post Type
Helps speed up wound healing!

Angle Type
Optimized in anterior area!

Mini Implant I-FIX

Angle, Post and O-ring types are applicable in small space between anterior teeth. Simple Surgical Tool: 1 Driver for 3 types of the mini implant.

Angle Type

- Specialized 2 pieces-design reinforce safe fixation
- Abutments are divided into Cemented and Angled for various cases and placement direction.

Post Type

- Suitable for narrow space in the maxillary and mandibular anterior teeth.
- One-body type design provides maximum strength for mastication.

O-Ring Type

Suitable for the edentulous patients.

| | D | C | L |
|------------|-----|-----|------|
| Angle Type | 2.0 | 1.4 | 10 |
| | 2.5 | 3.4 | 11.5 |
| | 3.0 | | 13 |
| Post Type | 2.0 | 2.0 | 10 |
| | 2.5 | 4.0 | 11.5 |
| | 3.0 | | 13 |
| Oring Type | 2.0 | 1.5 | 10 |
| | 2.5 | 3.5 | 13 |
| | 3.0 | | 16 |

S-Line Abutment



S-Line Abutment

Creates natural and functional emergence profile

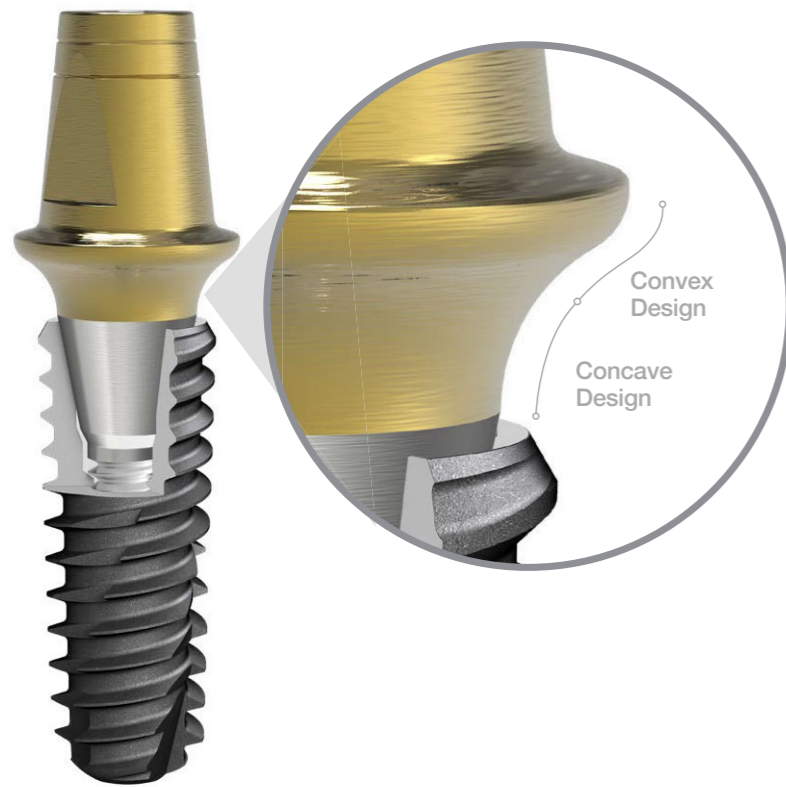

S-Line Abutment

Creates natural and functional emergence profile

- Prevents bone loss by avoiding interference with alveolar bone and increases the volume of the soft tissue around implant.
- Prevents infection from such a food particle.
- Increases aesthetic value.



Specifications

S-Line Healing Abutment

| | |
|----------|-----------------|
| Diameter | 4.5/5.5/6.5/7.5 |
| G.H | 2/3/4/5/6/7/9 |

S-Line Couple Abutment(Hex/N-Hex)

| | |
|----------|-----------------|
| Diameter | 4.5/5.5/6.5/7.5 |
| P.H | 5.5/7.0 |
| G.H | 2/3/4/5/6*/7* |

S-Line Sole Abutment

| | |
|----------|-----------------|
| Diameter | 4.5/5.5/6.5/7.5 |
| P.H | 5.5/7.0 |
| G.H | 2/3/4/5/6*/7* |

* 6/7mm : Coming Soon

S-Line Angled Abutment(Edge/Flat/N-Hex)

| | |
|----------|-------------|
| Diameter | 4.5/5.5/6.5 |
| Angle | 15°/25° |
| P.H | 5.5/7.0 |
| G.H | 3/4/5.5*/7* |

Multi Use Coping

Multi Use Coping



Clinical Video 1



Clinical Video 2



Clinical Video 3



Clinical Video 4



Multi Use Coping : Impression Coping + Impression Cap + Bite Cap

MUC is multi-functional coping which can be used for precise impression with Impression cap or Bite Cap accordingly after assembled with fixture.

1. When using Multi Use Holder

- Provide Holder (Short/Long Size) only for Multi Use Coping.(Holder consists of Body and Driver)
- Easy to move the Multi Use Coping into the oral cavity and assembling it in the fixed state when using the proper length

2. When using Multi Use Coping and Bite Cap

- Precise bite is possible by adjusting the height when taking bite
- Two options are provided (Short & Long) for different cases

3. When using Multi use coping and Impression Cap

- Provide precise placement when assembling the Impression Cap with cross section of cap
- Proper undercut provides a precise impression with pick up when removing the cap
- It can be used as a substitution for the Bite Cap for narrow cases

4. When using Multi use coping and Healing Cap

- It can be used as a substitute for a Healing Abutment after taking the impression with the Multi Use coping and assembling the Healing Cap
- Can be applied based on the type of case but providing the same Multi Use coping to the lab is mandatory. (Size information is mandatory for multiple cases)
- Remove Multi Use coping and Healing Cap inside of the mouth before installing the dental prosthesis

Simple Case → Use Impression Cap

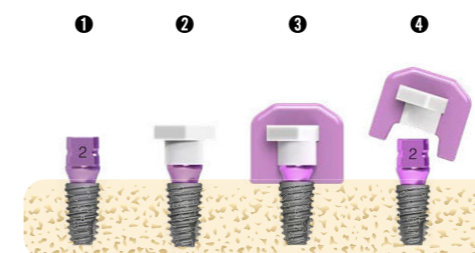

Multiple Case → Use Impression Cap

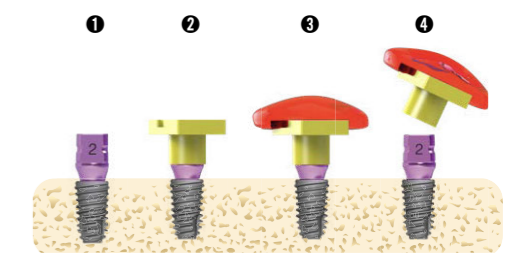

Use Bite Cap (Use Pattern Resin)

Magnetic Attachment

Strongly recommended for these type of people.

1. A person who feels difficult to remove a denture.
2. A person who cares denture hygiene.
3. A person who wants to avoid side pressure due to poor bone condition



Keeper

| Type | Connection | Diameter | Cuff | Int Type | | | |
|------|------------|----------|------|----------|------------|----------|---------|
| | | | | Type | Connection | Diameter | Cuff |
| Flat | Narrow | 4.4/4.9 | 1~8 | Flat | Regular | 4.4/4.9 | 1.5/2.5 |
| Dome | Regular | | | Dome | | | |

Retainer

| Type | 4.4 | 4.9 |
|------|----------|----------|
| Flat | Flat 4.4 | Flat 4.9 |
| Dome | Dome 4.4 | Dome 4.9 |

Mount Ring

| System | 4.4 | 4.9 |
|---------|-----|-----|
| S-Clean | | |
| I-Clean | | |

KERATOR

MALE CAP SET



3 lbs



1.5 lbs



Extra Light Angled



It can also be used for dentures that were previously used.



Positioning the existing denture, make a hole using Denture Bur. Pour Denture Resin into the hole to secure the metal housing and create a new denture.



If the metal housing is installed by combining the Blockout spacer in the mouth and pressing Denture with Denture Resin, undercutting and surrounding trimming are not required.



Implant Mandible Overdenture A



Implant Mandible Overdenture B

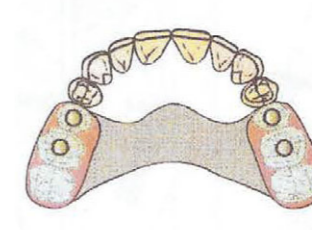

Implant Partial Denture



Implant Maxilla Overdenture

Clinical Images





























Ovis Bone Graft

Ovis Excellent Bone Regeneration

| | Specification | Size(mm) | Weight(g) |
|--|--|------------|-------------------------|
|  <p>Ovis BONE BCP</p> | <p>Biphasic calcium phosphate composed of Hydroxyapatite 20% + β-TCP 80%</p> <ul style="list-style-type: none"> · Osteoconductive synthetic bone graft with higher β-TCP content. · Excellent wettability · Easy manipulation · Biocompatibility and great bioactivity · Well-formed Macro/Micro porous · Porosity : 70% | S 0.3~0.5 | 0.1 / 0.25 / 0.5 / 1.0 |
| | | M 0.5~1.0 | |
| | | L 1.0~2.0 | |
|  <p>Ovis BONE HA</p> | <p>Great biocompatible and bioactive Hydroxyapatite 100%</p> <ul style="list-style-type: none"> · Osteoconductive synthetic bone graft · Bone void filler for dental surgery · Non toxicity · Non inflammatory nature · Easy manipulation · Well-formed Macro/Micro porous | 0.5 ~ 1.0 | 0.1 / 0.25 / 0.5 / 1.0 |
| | Specification | Size(mm) | Volume(cc) |
|  <p>Ovis ALLO</p> | <p>Freeze dried bone allograft composed of Cortical 50% + Cancellous 50%</p> <ul style="list-style-type: none"> · Osteoconduction and Osteoinduction · The used human anatomy which passed strict guidelines of FDA and KFDA · Production process by a single donor to prevent cross infection · Easy and simple syringe type | XS 0.2~0.5 | 0.3 / 0.6 |
| | | S 0.3~0.8 | |
| | | L 0.5~1.0 | |
| | Specification | Size(mm) | Weight(g) |
|  <p>Ovis XENO</p> | <p>Bovine bone grafting material of natural mineral cancellous bone composed of Double-coated Ca-P crystal + Calf bone</p> <ul style="list-style-type: none"> · Natural mineral bone obtained through strict manufacturing process · No immunologic rejection · Biocompatibility and great bioactivity · Easy revascularization of the bone graft site · Well-formed Macro/Micro porous similar to uman's cancellous bone | S 0.25~1.0 | 0.15 / 0.25 / 0.5 / 1.0 |
| | | L 1.0~2.0 | |
|  <p>Ovis XENO-P</p> | <p>100% cancellous swine bone that has been deproteinized.</p> <ul style="list-style-type: none"> · Safety from mad cow disease or Creutzfeldt-Jakob disease and so on · The most similar void fraction to that of human bone. · Excellent hydrophilicity and transparency · Biocompatible and excellent bone regeneration ability. · Surface void form of natural bone is maintained due to special processing technique. | S 0.25~1.0 | 0.15 / 0.25 / 0.5 / 1.0 |
| | | L 1.0~2.0 | 0.5 / 1.0 |

Ovis Membrane Materials

| | Specification | Size(mm) | Thickness(mm) |
|---|--|----------|---------------|
|  <p>Ovis BCP / Collagen MEMBRANE</p> | <p>Resorbable barrier membrane composed of Atelocollagen + BCP(Biphasic calcium phosphate)</p> <ul style="list-style-type: none"> · Biodegradable collagen membrane · UV cross-linking · Easy manipulation with soft and excellent wettability · Resorption period of 4-6months | 15 x 20 | 0.3 |
| | | 20 x 30 | |
| | | 30 x 40 | |

| | Specification | Type | | |
|---|---|---|--|--|
|  <p>Ovis TRM</p> | <p>None-resorbable membrane is made of Micro porous d-PTFE + Titanium</p> <ul style="list-style-type: none"> · Great handling and space formation ability · Easy to fix with bone screw or pin · Prevent both bacterial and cellular penetration into wound · Nutrients available for bone regeneration through membrane · Primary closure is not essential (Open membrane technique) · Easy removal with minimal or no incision · 23 various types and sizes |  PM1224A 12mmx24mm |  PM2530A 25mmx30mm |  PMB2325 25.16mmx23.56mm |
| | |  PM1424A 14mmx24mm |  PM3040SA 30mmx40mm |  PN2029(No Titanium) 29mmx19.82mm |
| | |  PM1725A 17mmx25mm |  PM3040A 30mmx40mm |  PMB2029 29mmx19.82mm |
| | |  PM2025A 20mmx25mm |  PM2536A 36mmx25mm |  PMB2127 27mmx21.44mm |
| | |  PM1319A 13mmx19mm |  PM3041A 41mmx30mm |  PMB2530 30mmx24.9mm |
| | |  PM1318A 13mmx18mm |  PMB2025 20mmx24.9mm |  PMB2028 20mmx28.4mm |
| | |  PMB2830 30mmx28.4mm |  PN2025(No Titanium) 20mmx25mm |  PN2530(No Titanium) 25mmx30mm |
| | |  PMB2021 20.71mmx19.8mm |  PN3040(No Titanium) 30mmx40mm |  PMB2021 20.71mmx19.8mm |

SAVE SINUS

SAVE SINUS

CRESTAL and LATERAL Approach KIT

KIT Code : DSSK

- Lateral Approach
- Crestal Approach
- Combined Component part

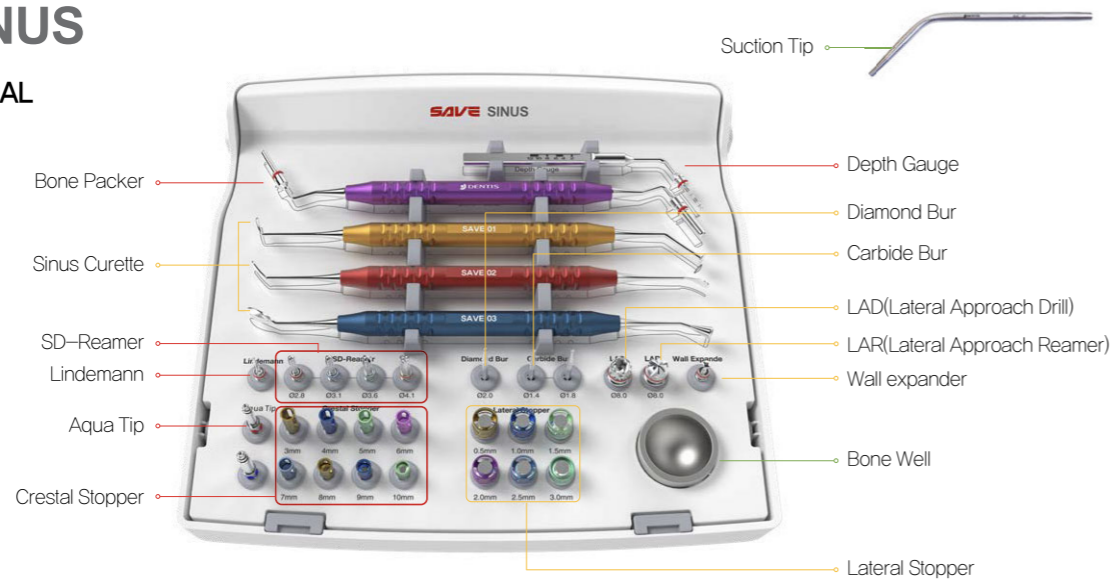

CRESTAL Approach

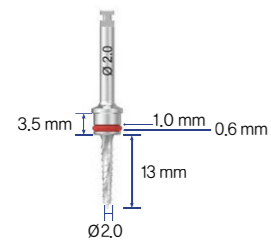

Lindemann Drill
 - Drill Length : 13mm
 - Diameter : Ø2.0
 - Recommended RPM : 800~1,200RPM



Reamer
 - Protect membrane perforation in case of Crestal Approach (Hatch Reamer)
 - Crestal Stopper System (3~12mm) (Check bone thickness before Stopper attachment)
 - Diameters : Ø2.8, Ø3.1, Ø3.6, Ø4.1
 - Recommended RPM : 800~1200RPM/ 50~100RPM

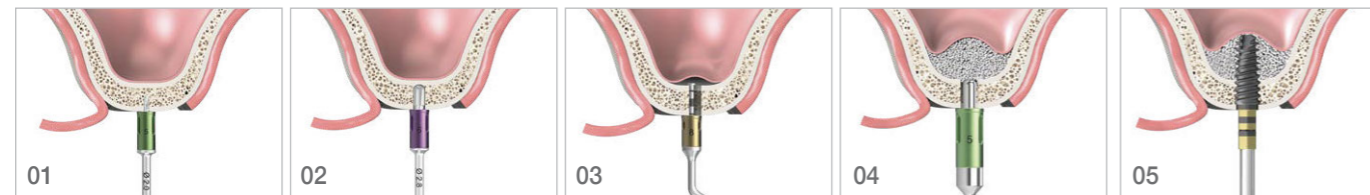

01 Crestal stopper is connected to Ø 2.0 Lindemann drill, and then choose the insertion site and proceed drilling 3mm shorter than remaining bone height.
 02 Choose 1mm higher Crestal Stopper and perform drilling with SD-Reamer.
 03 Use depth gauge to check the thickness of remaining bone.
 04 Connect the stopper with Bone Packer and fill in the bone material in the sinus.
 05 Implant Placement.

LATERAL Approach

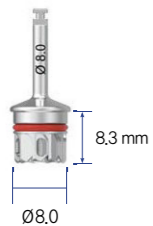

LAD(Lateral Approach Drill)
 - Curved blade relieve the impact of sinus membrane and generate bone lid.
 - Lateral Stopper System (0.5~3.0mm) (Check bone wideness before Stopper attachment by image diagnosis)
 - Recommended RPM : 800~1,200 RPM



LAR(Lateral Approach Reamer)
 - Blade design provides excellent cutting force and reduces the damage of the membrane by adopting a design in which the bonechip is filled in the blade during cutting
 - Lateral Stopper System
 - Recommended RPM :800~1,200 RPM

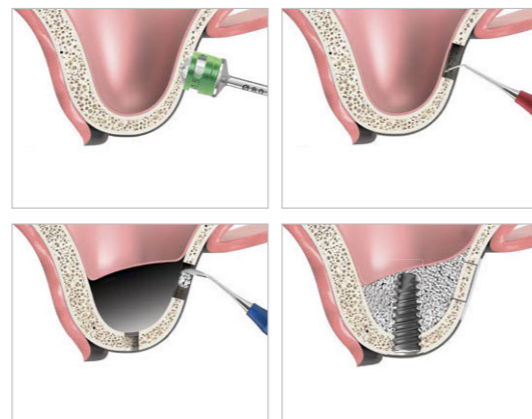

SAVE SEPTUM

SAVE SEPTUM DRILL

Tooth Extraction and Implant Placement in both anterior or posterior area

KIT Code : DSSDK

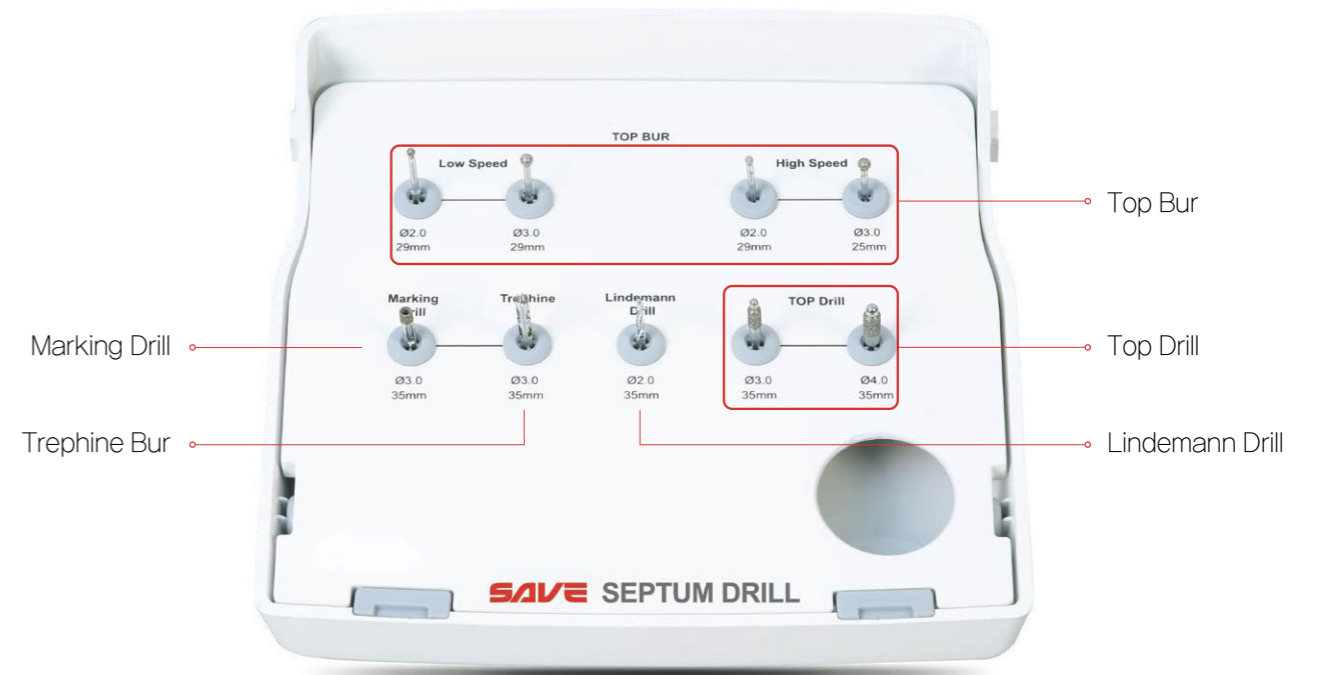

Anterior

Posterior

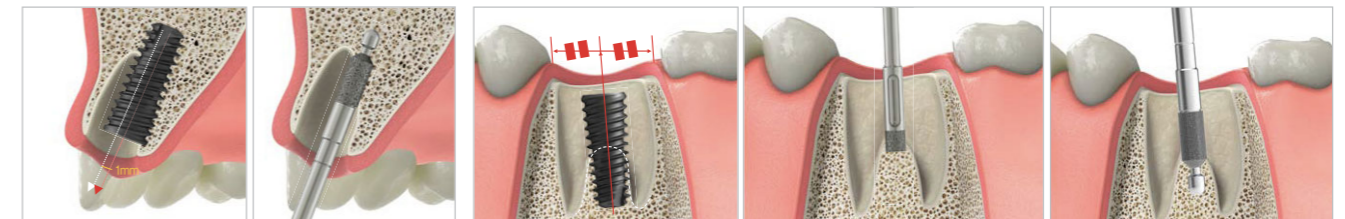

Use it while pressing towards palatal side

Top-bur

Removes granulation tissue and remained soft tissue after extracting tooth

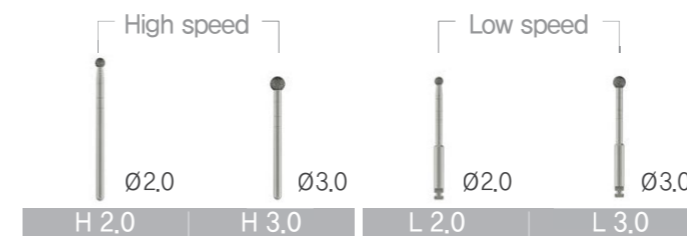

Marking Drill

Makes a mark of the exact SEPTUM site



Top-drill

Extend the site along with initial hole

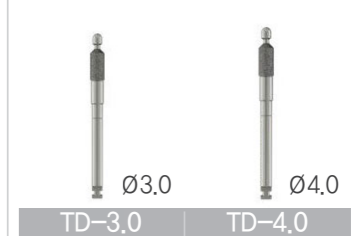

SAVE GBR

SAVE GBR

SAVE GBR KIT is composed of fixing screw such as Bone Screw and Bone Tack for GBR technique. Each of these components in the KIT are specialized for DENTIS products and provides successful GBR solution when using with Ovis Bone, SQ Fixture, OneQ Fixture.

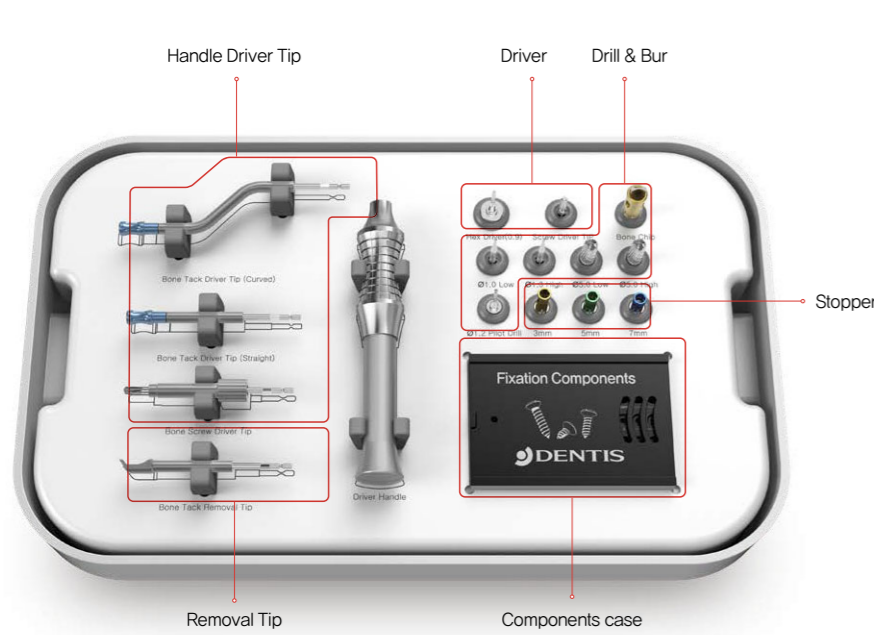

CODE : DGKT

Pilot Drill (ø1.2)

Perforation Bur (ø1.0)

Bone Trimming Bur (ø5.0)

Bone Chip Drill (ø5.0)

Bone Tack Driver(Straight/Curved)

Bone Tack Removal Tip

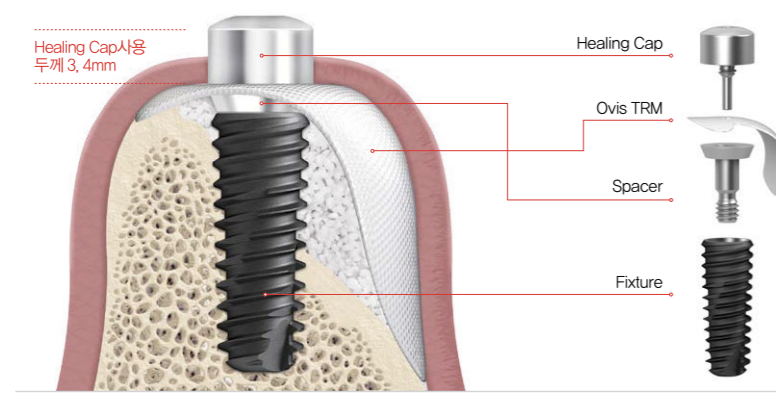
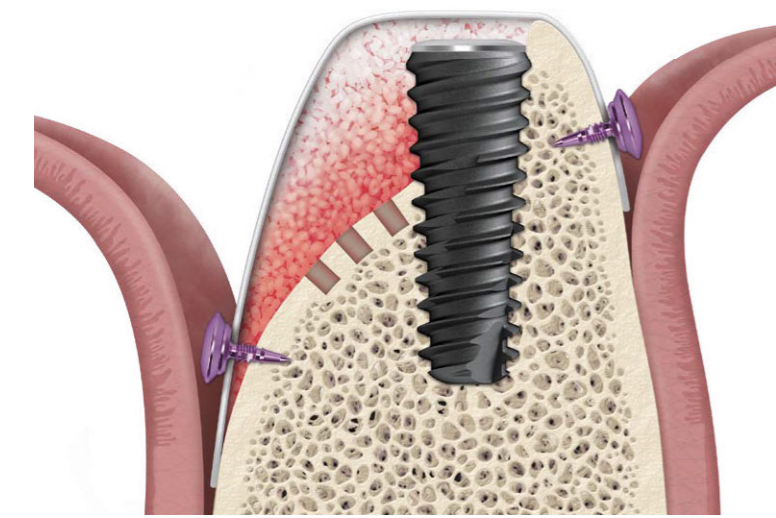
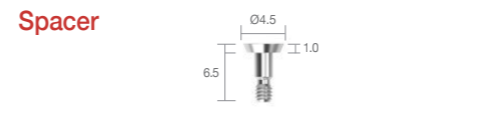
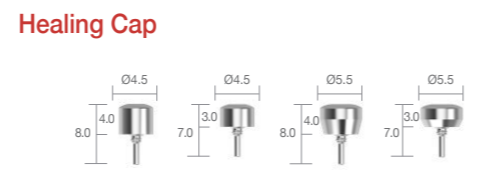
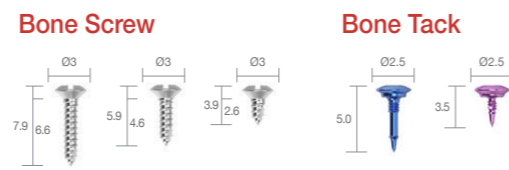

SAVE REMOVER

SAVE REMOVER

Assorted kits of components needed to remove failed implant fixture and fractured screw in simple and safe way.

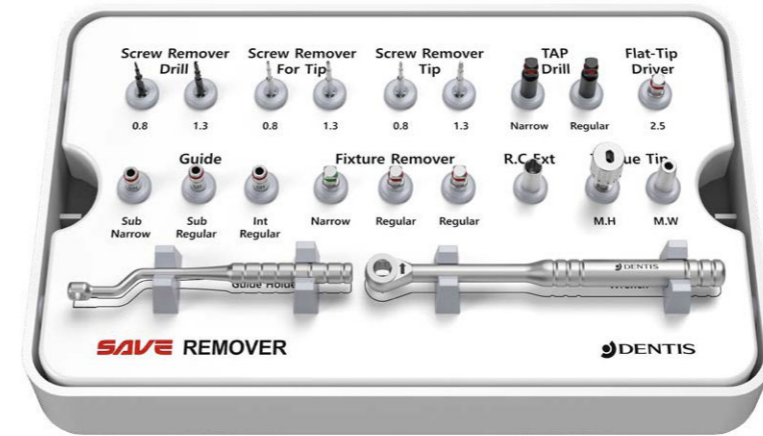

CODE : MSTSGD0101

Screw Remover System



Screw Remover For Tip

- After fixing the drill guide fastened to the Guide Holder to the fixture, insert it into the guide.
- After the drill touches the fractured side of the screw, it rotates counterclockwise.
- Recommend : Less Reverse 25RPM



Screw Remover Drill

- When Remover Drill couldn't remove the screw
- Insert holes in the drill guide under a sufficient irrigation and rotate counterclockwise to create on the fractured side of the screw
- Recommend : Reverse 1,200RPM



Screw Remover Tip

- After using the Remover Drill, rotate counterclockwise to remove the screw
- Recommend : Less Reverse 80RPM



Tap Drill

- After using the Remover Drill, rotate counterclockwise to remove the screw.
- Recommend : Below 100RPM

Fixture Remover System



Fixture Remover Screw

- Rotate counterclockwise to fix the implant fixture and remove the fixture
- Recommend : Less Reverse 50 RPM

R.C Ext(Extension)

- Connected with wrench when the surgical site is not accessible. (+10mm)

Guide Holder

- A guide that fixes to the implant fixture to prevent shaking during drilling.
- A holder that fastens and fixes the Guide Drill before or during the procedure to the implant fixture.

Torque Tip

- M,H : It is a device to tighten to the screw removal tip to manually remove the abutment screw.
- M,W: It is a device to fasten the abutment screw to the screw removal tip to remove it with a wrench.

Flat-Tip Driver

- Used to form a slot with a bur in case of fractured one-body implant or damage to the hex of upper structure.

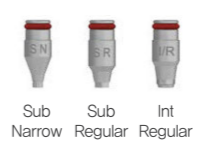

Guide Drill

- Use with Guide holder to prevent drill movement during drilling.

SAVE RIDGE

SAVE RIDGE KIT

SAVE RIDGE KIT is an all-around KIT for simple and stable implant placement in narrow ridge by Ridge Split and Ridge Expansion technique or the combination of Ridge Split & Expansion technique. It's even possible to place an implant without additional drilling through specially designed Expander Drill.

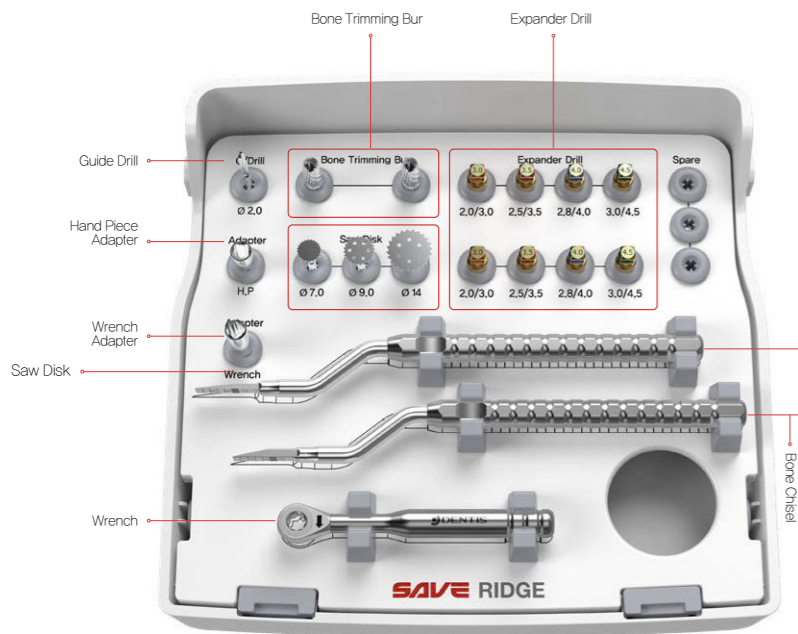

KIT Code : DSRK

RIDGE KIT with confidence in any case!

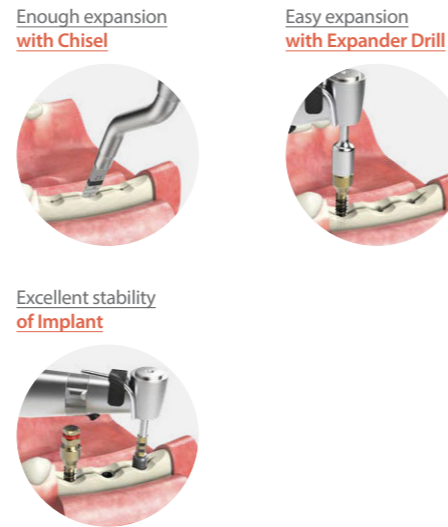

Excellent stability of Implant

Expander Drill

- Sequential expansion of holes formed by Guide
- Drill Diameter (Ø Maxillary / Mandibular) : Orange Ø2.0/3.0, Red Ø2.5/3.5, Blue Ø2.8/4.0, Green Ø3.0/4.5
- Laser marking
- It is recommended to expand Ø0.5 less than the fixture size.
- 2 Products for each size
- Recommend RPM : 25-35 RPM

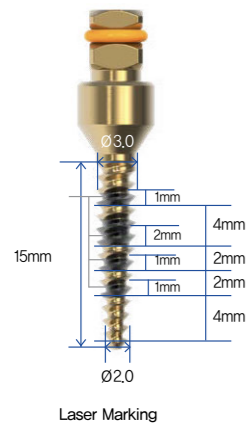

| CODE | MSTSGD0093 | MSTSGD0094 | MSTSGD0095 | MSTSGD0096 |
|----------------|------------|------------|------------|------------|
| Color | Orange | Red | Blue | Green |
| Diameter | Ø2.0/3.0 | Ø2.5/3.5 | Ø2.8/4.0 | Ø3.0/4.5 |
| Expander Drill | | | | |

Saw Disk

- For ridge splitting and cutting (Mesiodistal incision → Both buccolingual incision)
- Non-spatter design for safe cutting
- Recommend RPM : 1,200~1,500 RPM

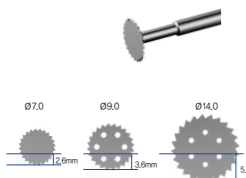

| Side Length | Code |
|-------------|------------|
| 7mm | MSTSGD0010 |
| 9mm | MSTSGD0011 |
| 14mm | MSTSGD0299 |

Chisel

- For initial bone expansion after using the saw disk.
- After using Saw Disk inserting a gap and use for initial expansion.
- Two thickness specifications to compensate for stable bone expansion, (1.5, 2.5mm)
- 140° curved for easy access to the posterior teeth.

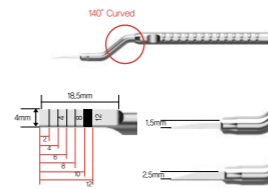

| Thickness | Code |
|-----------|------------|
| 1.5mm | MSTSGD0297 |
| 2.5mm | MSTSGD0298 |

SAVE WIDE CAP

SAVE WIDE CAP

SAVE WIDE CAP makes applying GBR in various situations easy and comfortable.

Advantage

- Simple GBR procedure
- It's easy to fix bone through the direct connection between the fixture and SWC
- Whether exposed or not, SWC can be used without worrying about inflammation
- It can be used as a flexible membrane replacement

Design

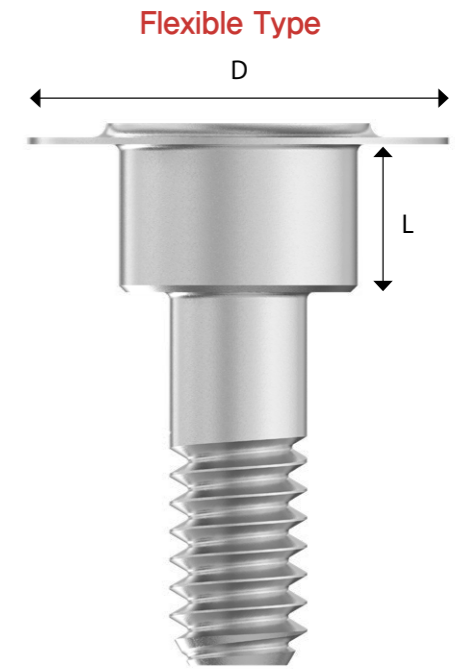

"Save wide cap" Process

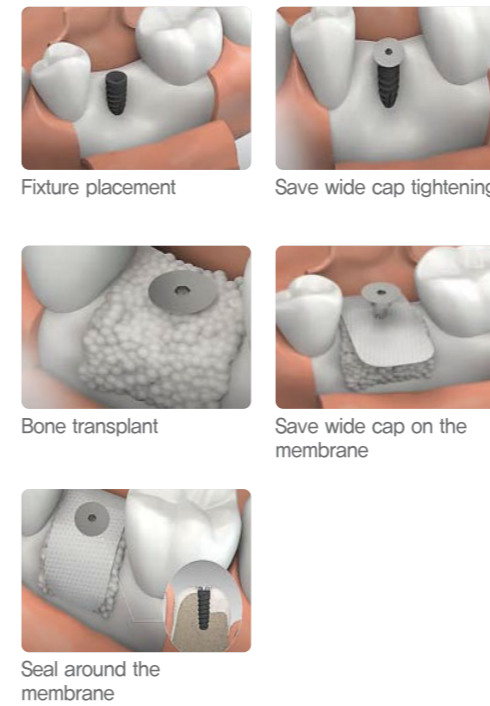

Application

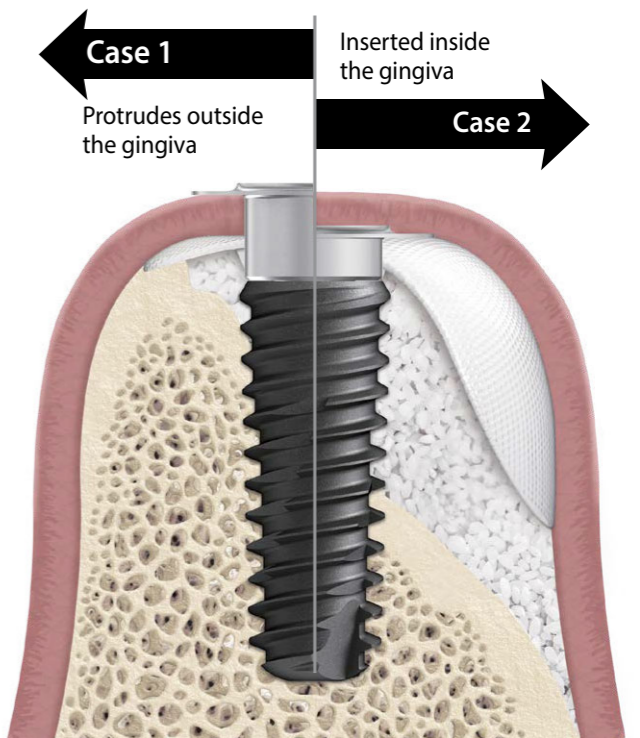

Apply an adsorption barrier to the upper fixation to minimize predictable skeletal formation and complications.

Specification

| D (Diameter) | Φ6 | Φ7 | Φ8 |
|--------------|-----|-----|-----|
| L (Length) | 2mm | 2mm | 2mm |
| | 3mm | 3mm | 3mm |
| | 4mm | 4mm | 4mm |

Louis Button II

Predictable Shape of Attached Gingiva!

Attached-Gingiva Former
Louis Button II



- ✓ 8 degrees wing declination for increased applied pressure
- ✓ Stopper to avoid detachment from healing abutment
- ✓ Applicable to most dental implant systems



* The easiest and Safest way to increase Attached -gingiva

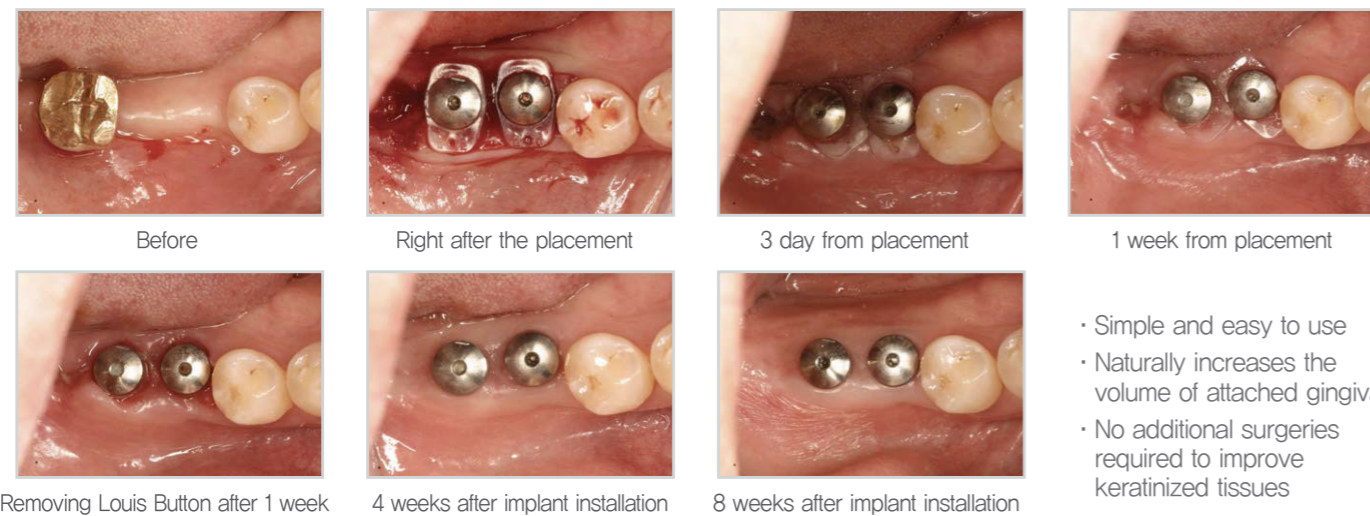

- Simple and easy to use
- Naturally increases the volume of attached gingiva
- No additional surgeries required to improve keratinized tissues

Guide Wheel

Guide Wheel

The easiest solution that can **find the position & direction of implant**

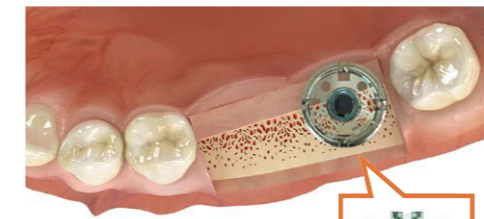

- + **Visible treatment**
-Secured visibility by transparent material
- + **Easy to use**
-Use immediately after connecting exclusive drill
- + **Reduced bone heating**
-Made the irrigation hole inside of wheel.
- + **Made the irrigation hole inside of wheel**
-Hygienic disposable product
- + **High frequency to use**
-From Single to multiple cases
- + **Reduced chair time**
-Predictable placement reduced operation time by comparing adjacent tooth
- + **Easy and economical Solution**
-Possible to use without using complex guide systems and loots



Guide Wheel

- ▶ Disposable operation tools help to decide the path and initial drilling point to secure the safety margin by imaging the shape and size of superstructure.
- ▶ Easy to find a place of fixture covered with the gum tissue, in case of the Second operation.

Guide Wheel Initial Drill

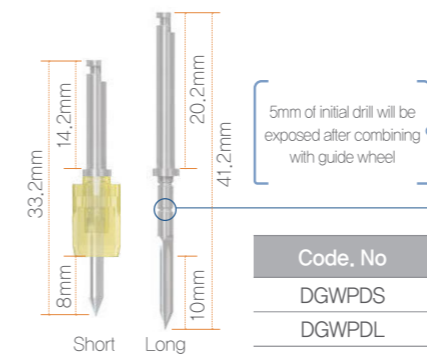

Guide Wheel

| Type | Incisor | Incisor/Premolar | Premolar | Premolar/Molar | Molar | Molar |
|----------------------|---------|------------------|----------|----------------|-------|-------|
| Guide Wheel Diameter | Ø6 | Ø7 | Ø8 | Ø9 | Ø10 | Ø12 |

▶ Be used in combination with initial drill to secure initial path and space for prosthetics.

| Code. No | DGW6 | DGW7 | DGW8 | DGW9 | DGW10 | DGW12 |
|----------|--------|------|------|-------|-------|-------|
| color | Yellow | Pink | Blue | Green | Black | Clear |
| Size | Ø6 | Ø7 | Ø8 | Ø9 | Ø10 | Ø12 |

Guide Pole

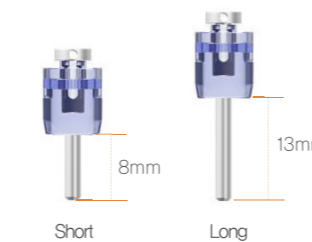

Be used in combination with guide wheel

Guide Pin



- ▶ Place in hole to select the imaginary location of tooth after drilling.
- ▶ Be used in case of implanting more than two fixtures.

| Code. No | DGWP6 | DGWP7 | DGWP8 | DGWP9 | DGWP10 | DGWP12 |
|----------|--------|-------|-------|-------|--------|--------|
| color | Yellow | Pink | Blue | Green | Black | Clear |
| Size | Ø6 | Ø7 | Ø8 | Ø9 | Ø10 | Ø12 |

IMPLANT MOTOR

X-CUBE

BLDC motor (Speed Range 0~50,000rpm) and Angle (Standard equipment 20:1) provides the optimum torque in surgery

- RPM : (20:1) 30rpm ~ 2,500rpm / (32:1) 20rpm ~ 1,562rpm
- Torque : (20:1) 5.0 ~ 55Ncm / (32:1) 5.0 ~ 65Ncm
- Gear ratio : 1:5 / 1:4 / 1:1 / 16:1 / 20:1 / 27:1 / 32:1 / 64:1

Program memory function

- 10 programable memories for setting Speed, Torque, Rotating Direction, Irrigation Pump
- Automatic overload protection function
- If the load on the Bur is higher than set Torque, the motor is stopped automatically after 2 seconds
- For releasing the overload function, push foot control pedal
- Actual RPM and Torque is indicated when motor is running, which makes user verify proper working condition during operation

Ergonomic foot control pedal

- The foot control pedal is designed ergonomically to control all the functions and it provides high convenience.
- Membrane touch display
- Self- diagnosis function



Traus SIP20

Maintenance Friendly Easy to disassemble by hand without any tools for internal cleaning and maintenance

- Maintenance friendly
- Intuitive user interface
- Real time torque & RPM display
- Motor auto-calibration function
- Efficient gear system with the latest technology

Control Box

- Input : AC 100-120 V, 220-240 V (50/60Hz)
- Output : 48 VA
- Fuse : 5 A / 2 A : Max. 90±20%ml / min
- Maximum Pumps
- Dimension : W 285.5 × D 261 × H 121.7 mm
- Weight : 3.42 kg C



REMEX



The **lightest** The **Smallest**
The **highest performance** of 70kV
Safe & Easy to use

REMEX

 **High Quality
Portable X-Ray Digital Camera**

- Conveniently transportable anywhere: office, surgery suites, humanitarian work
Easily take an x-ray anytime during procedures
- No cumbersome stands or cables
- Cordless, rechargeable batteries. More than 250 exposures per charge
- Lightweight, highly convenient. No motion artifacts; blur-free radiographs

Remex provides the best diagnostic imaging

REVOLUTION IN
MEDICAL DEVICES

Luvis C300 / C500

Luvis S200 / M200

Perfect Dental Light Even Cares for Your Eyes.
LUVIS!

Luvis C300

• **Detachable Handgrip**



• **Smart Sensor**



• **Hybrid LED Reflector C300**

The Luvis reflector's optical system reduces energy savings and heat emissions, and uses less power to control color temperature and pattern size.

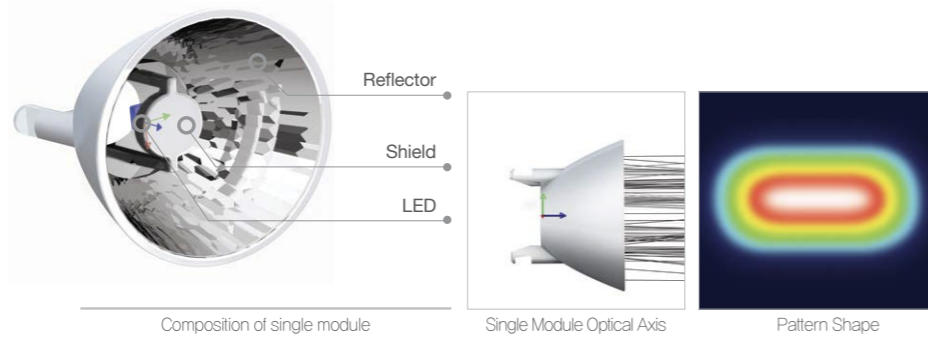

Luvis C500

• **Proximity Sensor**

Automatic ON/OFF when close within 1cm



• **Resin Cover**



• **Detachable Handgrip**



• **Camera**



• **Remote Control**

Medical LED Light System



Even Cares for Your Eyes



• **S200**

Max. 100,000 lx
CRI: Ra 90
3,800/4,300/4,800K



• **M200/M210**

Max. 120,000 lx
CRI: Ra 95, R9 90
M200: 4,300K
M210: 3,800/4,300/4,800K
Touch Sensor Control



• **M300/M310**

Max. 160,000 lx
CRI: Ra 95, R9 90
M300: 4,300K
M310: 3,800/4,300/4,800K
Touch Sensor Control



• **L200**

Max. 160,000 lx
CRI: Ra 95, R9 90
3,800/4,300/4,800K
Touch Sensor Control

Start Your Digital Guide System Now!

SQ GUIDE

Full Solution Guide system

- Place the implant in the correct position by virtually doing the implant placement through the software.
- Insert the implant in where you make a plan and have same-day prosthetic setting.

SQ Implant Only

- Computer guided implant placement for SQ Implant that has the advanced SLA surface
- SQ Implant Fixture Size
 - Diameter : Ø3.5, Ø4.0, Ø4.5, Ø5.0 – Length : 7.0mm, 8.0mm, 10.0mm, 12.0mm, 14.0mm



+ Drill without worrying about bone heating

Decreased bone heating due to influx of external irrigation through irrigation groove, regardless of implant hand piece.

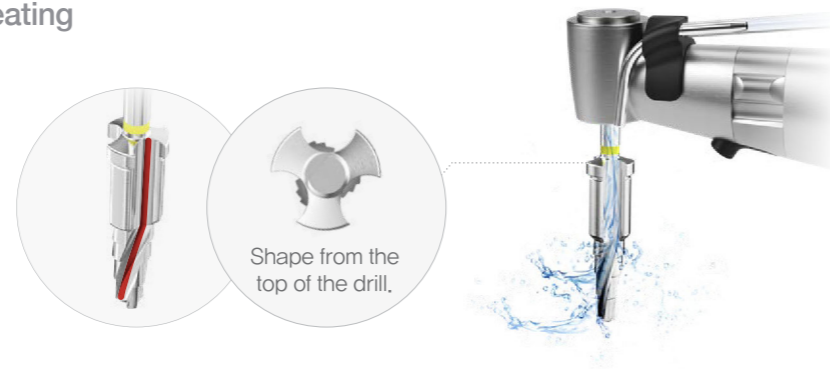

+ Fast implant placement with just 3 times of drilling.

ex) SQ Ø4.0 x 8mm (Normal) Offst 9.0mm

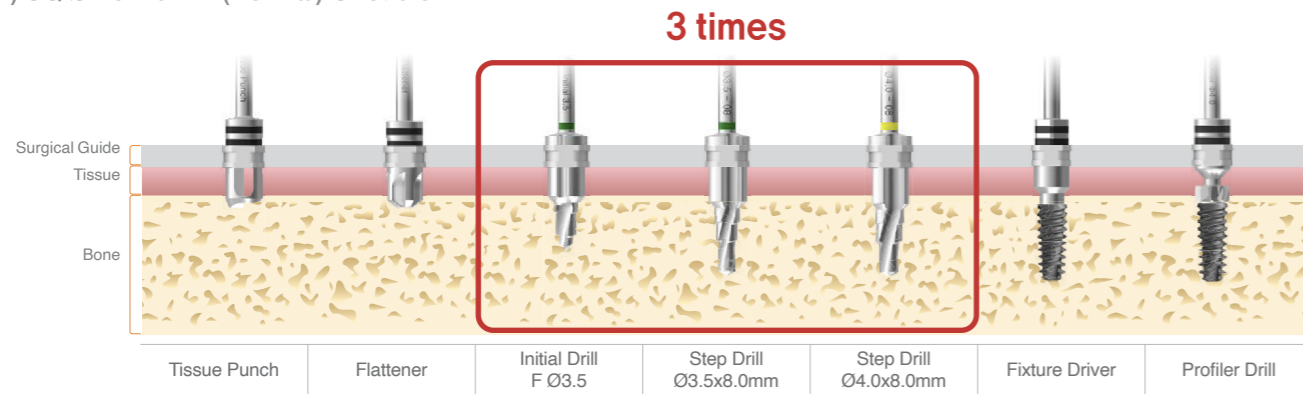

+ Ensure a safe drilling with titanium sleeve

SQ GUIDE Sleeve

- Metal sleeves made by titanium
- Safe and reduce error rate
- **3.5mm** : Molar or case of thick gingiva.
- **4.5mm** : Anterior or case of thin gingiva.
- **C-type** : Used in cases of mouth slightly open.



SQ MINI GUIDE

The kit specialized for the anterior region

Advantage

- High and Active drilling accuracy

Advantage

- The Anterior and Narrower interdental regions have never been treated easier.



+ Guide Sleeve

- Possible to choose between metal-sleeve and non-sleeve according to the interdental distance.
- Possible to choose metal sleeve Ø3.9 or Ø4.3

► Lateral side

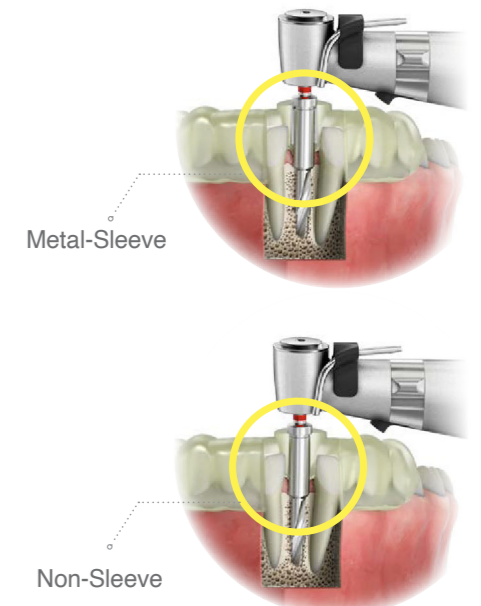
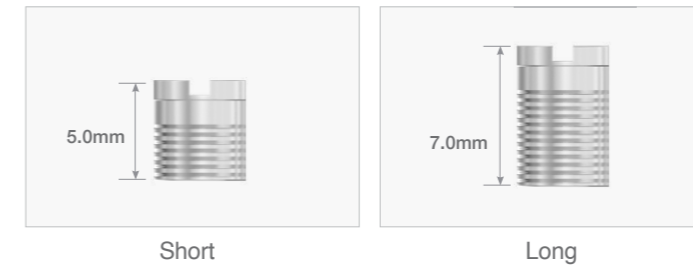

+ Long Drill & Holder

- Available to secure the correct direction in the early stage.

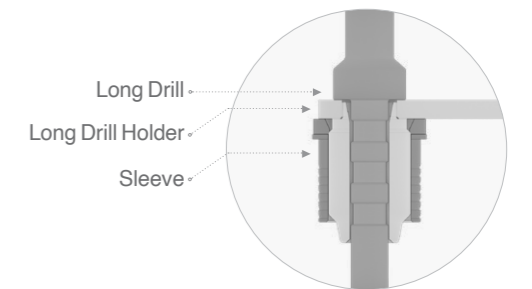

+ Offset

- 13mm(basic), 15mm

SQ SINUS GUIDE

SQ SINUS GUIDE

Full Flapless sinus surgery by crestal approach Solution Guide system

Safe Membrane Elevation

- The unique drill design enables safe elevation
- Sufficient bone removal is possible even with low-speed drilling
- Round tip drill prevents membrane perforation

3 Dimensional Elevation

- 3D elevation is possible even with irregular bone shape



+ NO Incision, NO Hydraulic pressure, Just with Guided drills. (Used with SQ Guide System)

Remaining bone 4mm, Normal bone Ø4.5 Fixture X 8mm, Offset : 9mm

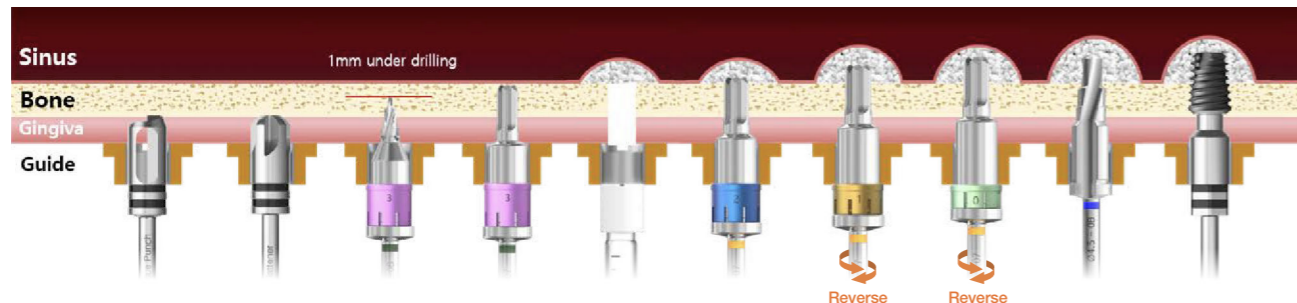

| KIT | SQ GUIDE | | SQ SINUS GUIDE | | GBR | SQ SINUS GUIDE | | | SQ GUIDE | | |
|---------|--------------|-----------|--------------------------|-----------------------|-----|-----------------------|-----------------------|-----------|--------------|-----|-----|
| | Tissue Punch | Flattener | Short Initial Drill Ø3.0 | Short SinusDrill Ø3.1 | | Short SinusDrill Ø3.6 | Step Drill Ø4.5x8.0mm | Placement | 2mm | 1mm | 0mm |
| Stopper | Not required | | | | | | | | Not required | | |

+ Work-flow



- + DentiQ Software
 - + ZENITH D 3D Printer
 - + SQ GUIDE KIT
 - + SIMPLE GUIDE Plus Kit
- You can make a surgical guide in your clinic.

3D Printer ZENITH

If you consider accuracy, economics and usability, the answer is **ZENITH** developed and supplied by a dental company 'DENTIS'



ZENITH L2

Specialized in printing dental model and surgical guide Entry-level 3D Printer.

ZENITH CURE

Two wavelengths '385 & 405nm' allow more stable and improved curing.

Application



Economical dental resins developed by DENTIS

Economical Material
self-developed material from DENTIS and offered at reasonable prices

High Formative Material
Smoother surface and high uniformity

Variety of Materials
Dental Model, Surgical Guide, Wax-up pattern, Temporary, Splint (Coming Soon)



MEDIT

MEDIT Line up

Unleash Your Clinic's Potential



MEDIT i600 The Simplest. The Easiest.



MEDIT

MEDIT i700

First Look at the Medit i700

Medit i700 makes the scanning experience a comfortable one for both the dentist and patient. With both powerful hardware and intelligent software, the full-feature Medit i700 is the key to unleash your clinic's full potential.



MEDIT i700 wireless

- Full arch accuracy: 10.9 μm ± 0.98
- Up to 70 FPS

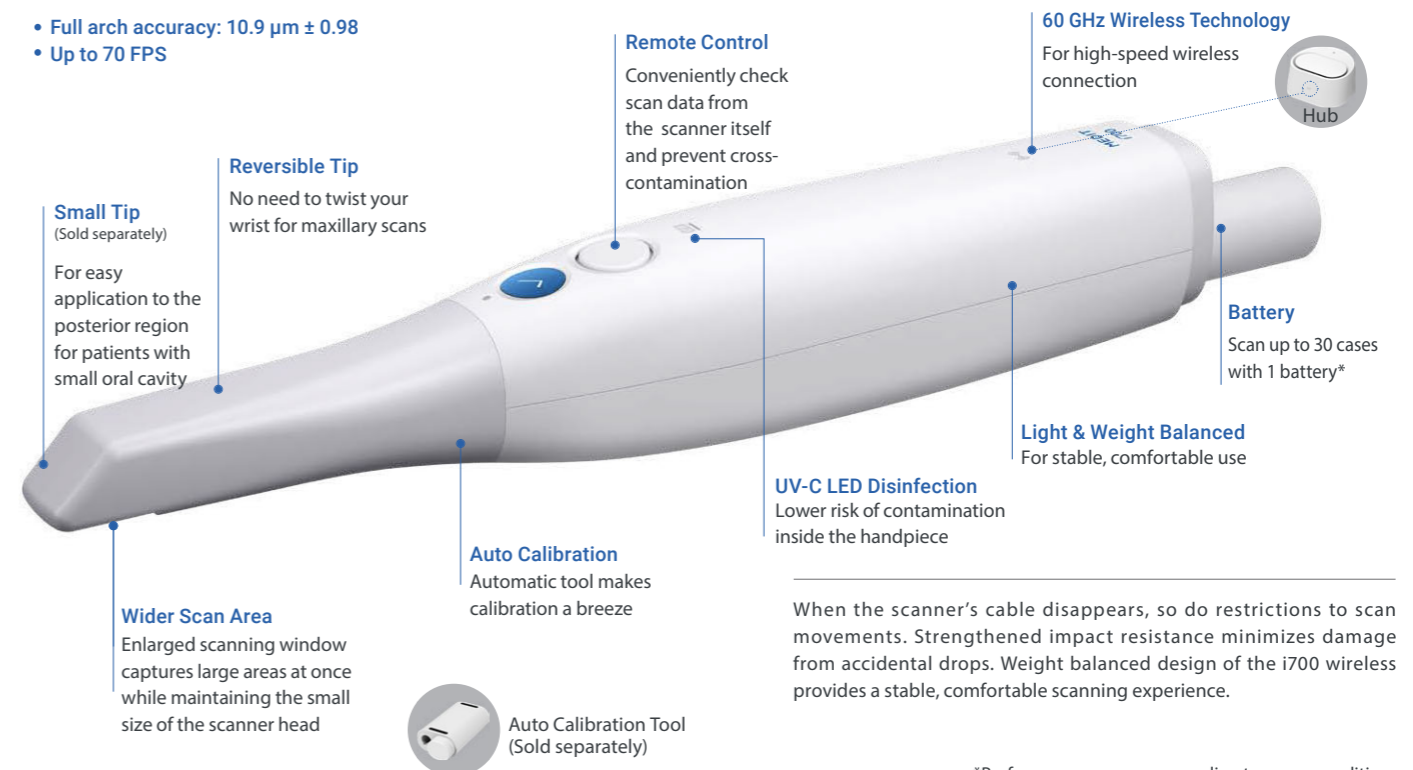

When the scanner's cable disappears, so do restrictions to scan movements. Strengthened impact resistance minimizes damage from accidental drops. Weight balanced design of the i700 wireless provides a stable, comfortable scanning experience.

*Performance may vary according to usage conditions.

SQUVA

SQUVA

SQ UV Activator

ENHANCE YOUR IMPLANT SURFACE
10 SECONDS IS ALL IT TAKES!



Hydrophilic Test



Implant cell adhesion 7th day of cell proliferation

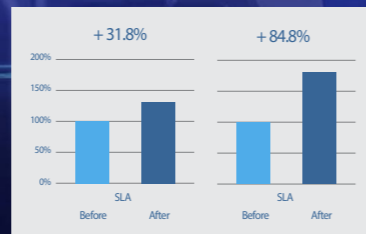

UV treatment increases cell adhesion by about 31% and increases cell proliferation by about 84%

DUST COLLECTOR

PORTABLE DUST COLLECTOR



Powerful Suction
A magnet provides easy removal and a maximum length of 500mm increases the bag capacity



Wire-free
Wireless type



PM2.5 Filter
We applied PM 2.5 filter to remove 99% of ultra fine dust.



IR Sensor
The use of Human Body Detection Sensor (PIR) reduces button touch and is excellent for preventing cross-infection.

BONE PROFILER KIT

BONE PROFILER KIT

REMOVE BONE SAFELY WITHOUT ANY DAMAGE ON FIXTURE

No Interference!

Makes the abutment fully seated by removing excess bone around the implant.

Safety Gap (0.1mm)

0.1mm Safety Gap prevents damage to fixture

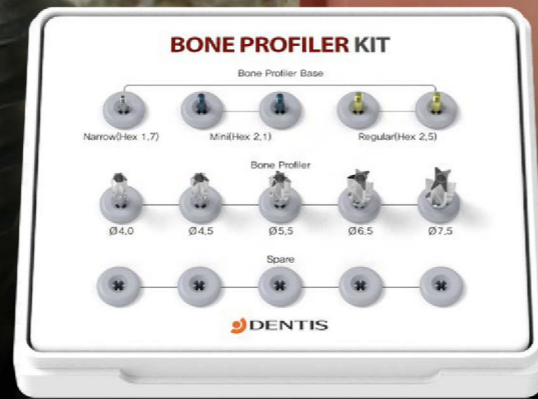
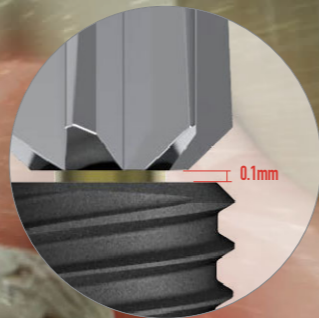

DENOPS

DENOPS

DENTIS No Pain System



DENOPS-i

First in the World! Portable Intraosseous Anesthetic System

DENOPS-i

“
Achieve Perfection in
Anesthesia
”

Injection rate
confirmation LED

Injection amount
confirmation LED

► **Control box**

- Possible to move with battery installed
- Mounting on top of the control box enables stable mounting

► **LCD screen**

- Operation status / setting information display



► **Relieve Patient Discomfort**

- Pain due to an injection in the cancellous bone
- Soft tissue paralysis of lips, tongue, and cheeks
- Patient's phobia

► **Foot Controller**

- Easy to use wirelessly
- Easy installation with 1:1 connection

► **Change Mode**

- Complete digital anesthesia equipment capable of intraosseous/infiltration/transfer anesthesia

LUVIS CHAIR

C Class(Clinic)

Technology
Comfort
Convenience
Safety

Slim and
Strong

Z-type vertical operation



tilting function



2-joint headrest

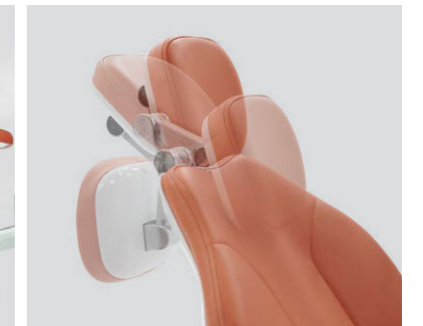

E Class(Examination)



S Class(Surgery)



DICAON 4D



Set up the Real Virtual
DICAON 4D

New Era of Digital Dentistry
Now you can set up a digital clear aligner in the infirmary!

DICAON 4D is a result of successful combination of computer service and clear aligner orthodontics science technology of South Korea. In short, it is a next-generation clear aligner orthodontics software.



Specialized clinical clear aligner
Increase set-up success rate.



Adopted IT Advanced Technology
Collaboration & Excellence
Rendering Speed



Analysis and Guide Functions
Accurate Diagnostics & Planning



Intuitive user interface
Easy and Comfort of setup work



Link to Clear Aligner Academy
Maximize user skills

+ Study Model Creation

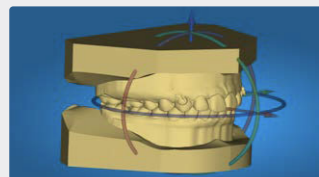

+ Margin Line

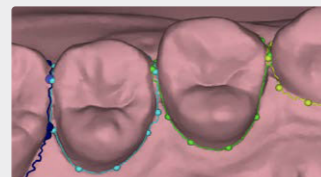

+ Center of Rotation



+ Angle Distance Table

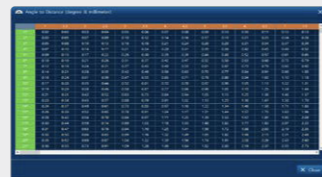

EVERY 10 / DOS

every 10™

Anytime
Anywhere
10minutes per day!
EVERY 10



Every10 is the combination of the vibration and laser.

Vibration and laser light sources are known in many medical device thesis. Shortening the calibration period! Pain relief! Promote Healing Speed and reduce inflammation.

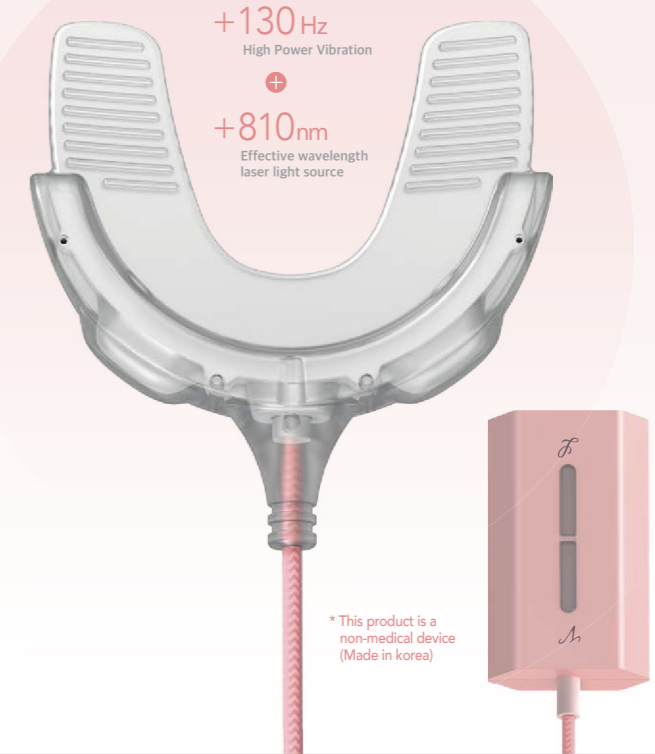

* This product is a non-medical device (Made in Korea)

DOS
Dentis Orthodontic Screw

DOS is 'Orthodontic' mini screw developed by DENTIS. Special design for Root Parallel placement minimizes failure rate and prevent root contact problem.



Individual Packing

Sterilized Individual packing(disposable)

Pharrel placement

Designed for Root Parallel

Great fixation

Minimize failure rate with optimal design

O-Type

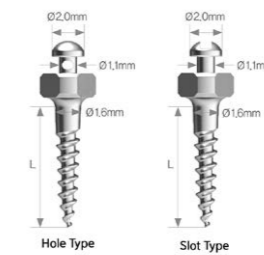

• **Direction & Position check**
- Easy to check with Triangle shaped head

• **Multiple use of Design**
- Maximum anchorage control
- tooth intrusion
- midline correction
- total arch distalization
- Impacted teeth correction
- Intermaxillar correction

• **Can be hygienic in individual disinfection packing.**

P-Type



• **Root parallel placement screw.**

- Great Initial stability
- Failure rate minimizing
- No Root damage

• **Immediate Torque loading check.**

• **More comfort and Less Inflammation For Free gingival mucosa or thicker gingiva.**



Case of premolar extraction. Placed as anchorage, for rearward move. Placed between premRewardolar and molar move for anterior teeth. For Young patient with soft bone Total arch distalization with P type. Mandibular 2nd Molar erection.

